

## Data Sheet

**Customer:**

**Product:** High Ohmic/High Voltage Metal Glaze Leaded Resistors —  
MGR Series

**Sizes.:** 0623/0932/1145/1550/1760

**Issued Date:** 16-Mar-23

**Edition:** REV.A7



VIKING TECH CORPORATION  
光韻科技股份有限公司  
No.70, Guangfu N. Rd., Hukou  
Township, Hsinchu County  
303, Taiwan (R.O.C)

TEL:886-3-5972931  
FAX:886-3-5972935•886-3-5973494  
E-mail:sales@viking.com.tw

VIKING TECH CORPORATION KAOHSIUNG BRANCH  
光韻科技股份有限公司高雄分公司  
No.248-3, Sin-Sheng Rd., Cian-Jhen Dist., Kaohsiung,  
806, Taiwan

TEL:886-7-8217999  
FAX:886-7-8228229  
E-mail:sales@viking.com.tw

VIKING ELECTRONICS (WUXI) CO., LTD.  
光韻電子(無錫)有限公司  
No.22 Xixia Road, Machinery & Industry Park,  
National Hi-Tech Industrial Development Zone  
of Wuxi, Wuxi, Jiangsu Province, China  
Zip Code:214028  
TEL:86-510-85203339  
FAX:86-510-85203667•86-510-85203977  
E-mail:china@viking.com.tw

Produced by (QC)	Checked (QC)	Approved by (QC)	Prepared by (Sales)	Accepted by (Customer)
16-Mar-23	16-Mar-23	16-Mar-23	16-Mar-23	
<i>Kris Chen</i>	<i>Ben Chang</i>	<i>Ben Chang</i>		

## High Ohmic/High Voltage Metal Glaze Led Resistors

### ■ Features

- Coat-Insulated Metal Glazed Fixed Resistors (RoHS compliant)
- Higher working voltage
- High pulse loading capability
- Resistance to high Temp/Humidity
- Highly stable performance and highly reliable

### ■ Construction

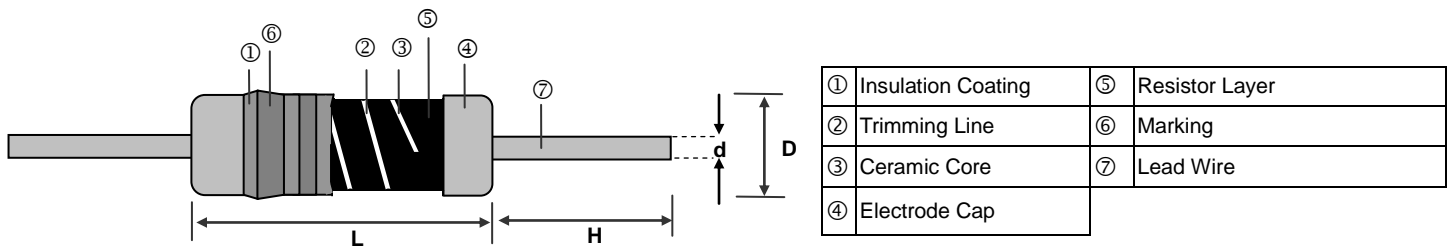

### ■ Dimensions

Unit: mm

Type	L	D	H	d
MGR0623	6.3±0.5	2.3±0.3	28±2.0	0.55±0.03
MGR0932	9.0±0.5	3.2±0.5	26±2.0	0.65±0.03
MGR1145	11.5±1.0	4.5±0.5	35±2.0	0.78±0.03
MGR1550	15.5±1.0	5.0±0.5	32±2.0	0.78±0.03
MGR1760	17.5±1.0	6.0±0.5	35±2.0	0.78±0.03

### ■ Part Numbering

MGR	0932	F	T	F	U	1004	S
Product Type	Dimensions (LxD)	Resistance Tolerance	Packaging Code	TCR (PPM/°C)	Power Rating	Resistance	Special
	0623: 6.3x2.3 0932: 9.0x3.2 1145: 11.5x4.5 1550: 15.5x5.0 1760: 17.5x6.0	F: ±1% G: ±2% J: ±5%	A: Ammo T: Taping Reel	E: ±100 F: ±200 I: ±500	V: 1/4W U: 1/2W T: 1W S: 2W R: 3W D: 5W	1003: 100KΩ 1004: 1MΩ 1006: 100MΩ	S: Silicone Resin E: Epoxy Resin

**Derating Curve**

**Hot-Spot Temperature**

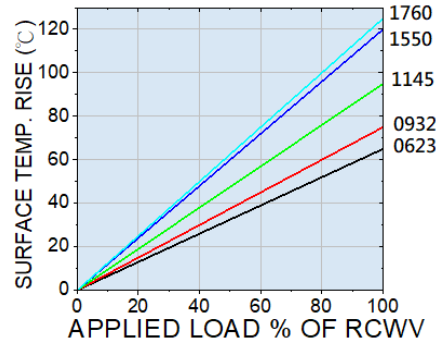
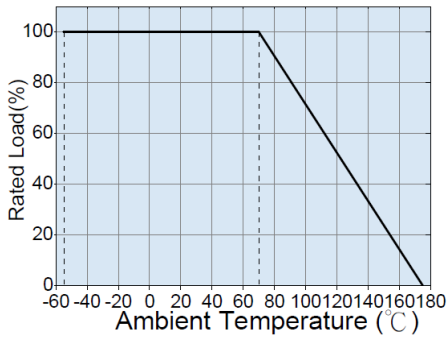

**Standard Electrical Specifications**

Item Type	Power Rating at 70°C	Operating Temp. Range		Max. Working Voltage	Max. Overload Voltage	Dielectric Withstanding Voltage		Resistance Range			TCR (PPM/°C)	Measured
		Silicone Resin	Epoxy Resin			Silicone Resin	Epoxy Resin	±1%	±2%	±5%		
0623	1/4W	-55 ~ 225°C	-55 ~ 155°C	DC1600V AC1150V	DC2000V AC1500V	400V	500V	100KΩ~1MΩ	±100	DC100V 100K≤R<1M  DC1000V 1M≤R		
0932	1/2W			DC3500V	4000V	500V	700V	100KΩ~10MΩ	±200			
1145	1W			DC4500V	5000V	500V	1000V	100KΩ~1MΩ	±100			
1550	2W			DC7000V	14000V	700V	1200V	100KΩ~10MΩ	±200			
1760	3W			DC12000V	16000V	1000V	1200V	100KΩ~10MΩ	±200			
								11MΩ~500MΩ	±500			
								100KΩ~10MΩ	±100			
								100KΩ~10MΩ	±200			
								11MΩ~500MΩ	±500			
								100KΩ~1MΩ	±100			

**High Power Rating Electrical Specifications**

Item Type	Power Rating at 70°C	Operating Temp. Range		Max. Working Voltage	Max. Overload Voltage	Dielectric Withstanding Voltage		Resistance Range			TCR (PPM/°C)	Measured
		Silicone Resin	Epoxy Resin			Silicone Resin	Epoxy Resin	±1%	±2%	±5%		
0623	1/2W	-55 ~ 225°C	-55 ~ 155°C	DC1700V	2500V	400V	500V	100KΩ~1MΩ	±100	DC100V 100K≤R<1M  DC1000V 1M≤R		
0932	1W			DC4000V	4500V	500V	700V	100KΩ~10MΩ	±200			
1145	2W			DC5000V	10000V	500V	1000V	100KΩ~1MΩ	±100			
1550	3W			DC10000V	14000V	700V	1200V	100KΩ~10MΩ	±200			
1760	5W			DC13000V	18000V	1000V	1200V	100KΩ~10MΩ	±200			
								11MΩ~500MΩ	±500			
								100KΩ~1MΩ	±100			
								100KΩ~10MΩ	±200			
								11MΩ~500MΩ	±500			
								100KΩ~1MΩ	±100			

Operating Voltage= $\sqrt{P \cdot R}$  or Max. operating voltage listed above, whichever is lower.  
 Overload Voltage= $2.5 \cdot \sqrt{P \cdot R}$  or Max. overload voltage listed above, whichever is lower.  
 Value Range for standard resistance, below or over this resistance on request.

**Silicone Resin coating color : Brown (Flame-Proof)**

**Epoxy Resin coating color : Light Blue**

**Environmental Characteristics**

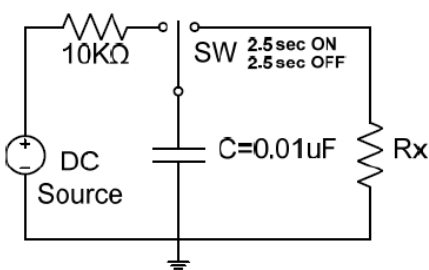
Item	Requirement	Test Method						
Temperature Coefficient(T.C.R)	As Spec	Resistance value at room +25°C temperature and room temperature+125°C						
Short Time Overload	±(1.0%+0.05Ω)	<b>JIS-C-5201-1 5.5</b> RCWV*2.5 or Max. overload voltage whichever is lower for 5 seconds						
Insulation Resistance	±10,000MΩ Over	<b>MIL-STD-202F Method 302</b> 500±50V DC During 1 min V-Block method						
Endurance	±(3.0%+0.05Ω)	<b>MIL-STD-202F Method 108A</b> 70±2°C, RCWV for 1000 hrs with 1.5 hrs "ON" and 0.5 hrs "OFF"						
Humidity	±(5.0%+0.05Ω)	<b>MIL-STD-202F Method 103B</b> 40±2°C, 90~95% R.H., for 1000 hrs (for epoxy resin) with 1.5 hrs "ON" and 0.5 hrs "OFF"						
Dielectric Withstanding Voltage	By Type	<b>MIL-STD-202F Method 301</b> In V-Block for 1 minute						
Intermittent Overload	±(1.0%+0.05Ω)	<b>JIS-C-5201-1 5.8</b> 4 times RCWV for 10000 cycles with 1sec "ON" and 25 sec "OFF"						
Resistance To Soldering Heat	±(1.0%+0.05Ω)	260°C±5°C for 2±1 seconds						
Terminal Strength	Tensile: ≥ 2.5kg	Direct Load for 10 sec. In the direction off the terminal leads						
Resistance to Solvent	No abnormality in coatings and markings	IPA for 5±0.5 Min. with ultrasonic						
Anti Surge characteristics	± ( 10% + 0.05Ω )	Discharge Test : 0.01uf capacitor Discharge Pulse 10 time. (1 pulse / 5sec. max)						
								
		<table border="1"> <tbody> <tr> <td>Type</td> <td>0623</td> <td>0932 / 1145 / 1550</td> <td>1760</td> </tr> <tr> <td>Voltage</td> <td>3KV</td> <td>10KV</td> <td>15KV</td> </tr> </tbody> </table>	Type	0623	0932 / 1145 / 1550	1760	Voltage	3KV
Type	0623	0932 / 1145 / 1550	1760					
Voltage	3KV	10KV	15KV					

RCWV(Rated continuous working voltage)=  $\sqrt{P \cdot R}$  or Max. Operating voltage whichever is lower.

■Storage Temperature: 15~28°C; Humidity < 80%RH

**■ Taping/Packing Specifications**

1. Standard Type (Reel & Ammo)

Packing Methods

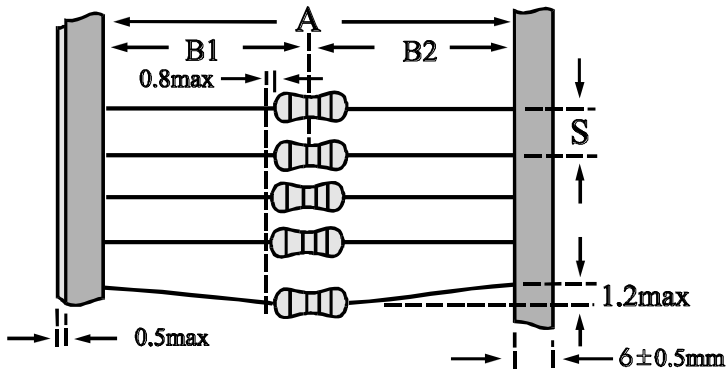

Reel Packing

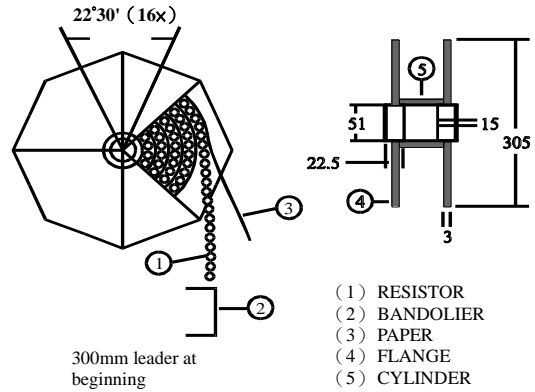

Ammo Packing

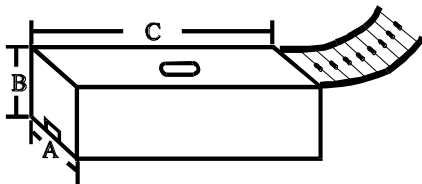

Unit: mm

Packaging Type	Packing Methods			Reel Packing		Ammo Packing			
	A	B1-B2 Max	S	Across Flange (A)	Qty	A	B	C	Qty
0623	52+1/-0	1.2	5±0.3	72	5,000	79±2	100±3	257±5	5,000
	26+0.5/-0	1.0				52±2	109±3	252±5	
0932	52+1/-0	1.2	5±0.3	72	2,500	79±2	58±3	257±5	1,000
1145	73+1/-0	1.5	5±0.3	95	2,000	103±2	82±3	262±5	1,000
	52+1/-0					81±2	85±3	256±5	
1550	73+1/-0	1.5	10±0.8	95	1,000	103±2	96±3	265±5	1,000
	52+1/-0					82±2	108±3	258±5	
1760	73+1/-0	1.5	10±0.8	95	1,000	103±2	82±3	262±5	500

■ **Marking & Resistance Tolerance**

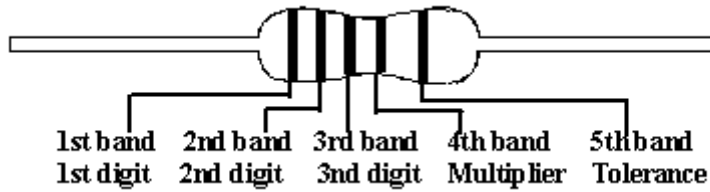
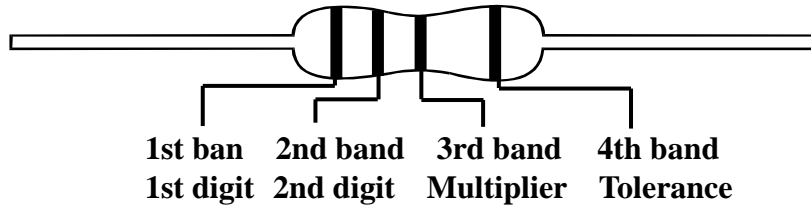

Color	Digit	Multiplier	Tolerance	
Without	-	-	-	-
Silver	-	10 <sup>-2</sup>	±10%	K
Gold	-	10 <sup>-1</sup>	±5.0%	J
Black	0	10 <sup>0</sup>	-	-
Brown	1	10 <sup>1</sup>	±1.0%	F
Red	2	10 <sup>2</sup>	±2.0%	G
Orange	3	10 <sup>3</sup>	-	-
Yellow	4	10 <sup>4</sup>	-	-
Green	5	10 <sup>5</sup>	-	-
Blue	6	10 <sup>6</sup>	-	-
Violet	7	10 <sup>7</sup>	-	-
Grey	8	10 <sup>8</sup>	-	-
White	9	10 <sup>9</sup>	-	-

±5.0%	E-24	1.0	1.1	1.2	1.3	1.5	1.6	1.8	2.0	2.2	2.4	2.7	3.0	3.3	3.6	3.9	4.3	4.7	5.1	5.6	6.2	6.8	7.5	8.2	9.1	
±2.0%																										
±1.0%																										