

Data Sheet

Customer:

Product: Conductive Polymer Aluminum Solid Electrolytic Capacitors – AVEA Series

Sizes.: 0506/0645/0606/6102/0807/0810/0812/1012

Issued Date: 09-Dec-20

Edition: REV.A2



VIKING TECH CORPORATION
光頡科技股份有限公司
No.70, Guangfu N. Rd., Hukou
Township, Hsinchu County
303, Taiwan (R.O.C)

TEL:886-3-5972931
FAX:886-3-5972935•886-3-5973494
E-mail:sales@viking.com.tw

VIKING TECH CORPORATION KAOHSIUNG BRANCH
光頡科技股份有限公司高雄分公司
No.248-3, Sin-Sheng Rd., Cian-Jhen Dist., Kaohsiung,
806, Taiwan

TEL:886-7-8217999
FAX:886-7-8228229
E-mail:sales@viking.com.tw

VIKING ELECTRONICS (WUXI) CO., LTD.
光頡電子(無錫)有限公司
No.22 Xixia Road, Machinery & Industry Park,
National Hi-Tech Industrial Development Zone
of Wuxi, Wuxi, Jiangsu Province, China
Zip Code:214028
TEL:86-510-85203339
FAX:86-510-85203667•86-510-85203977
E-mail:china@viking.com.tw

Produced by (QC)	Checked (QC)	Approved by (QC)	Prepared by (Sales)	Accepted by (Customer)
09-Dec-20	09-Dec-20	09-Dec-20	09-Dec-20	
<i>Kris Chen</i>	<i>Ben Chang</i>	<i>Ben Chang</i>		

Conductive Polymer Aluminum Solid Electrolytic Capacitors



■ Features

- Standard SMD type
- Rated voltage : 2.5~25Vdc
- Endurance : 2,000 hours at 105°C
- Suitable for DC-DC converters, voltage regulators and decoupling applications
- RoHS Compliant

■ Construction

– Vertical type capacitors shall be enclosed wound element, where anode and cathode foils with lead wire termination shall be wound together with separator, with conductive polymer electrolyte in a plastic coated aluminum case and sealed up tightly with rubber.

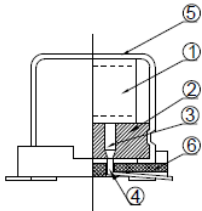

①	Element	④	Lead Wire
②	Seal	⑤	Case
③	Aluminum Tab	⑥	Base Plate

■ Dimensions

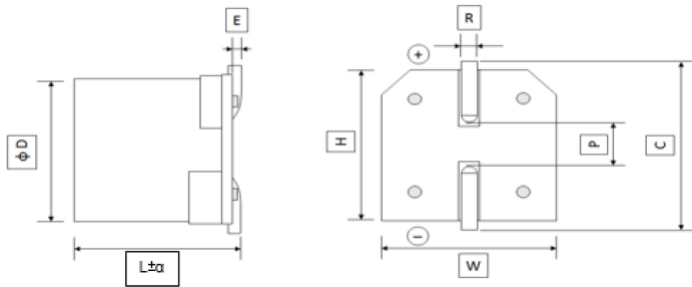

Unit: mm

Type	D	L	α	E	W	H	C	R	P
AVEA0506	5.0±0.5	5.8	±0.2	0.00~0.20	5.3±0.2	5.3±0.2	6.0±0.2	0.5~0.8	1.4±0.3
AVEA0645	6.3±0.5	4.5	-0.2~+0.1	0.00~0.20	6.6±0.2	6.6±0.2	7.3±0.2	0.5~0.8	2.1±0.3
AVEA0606	6.3±0.5	5.8	±0.2	0.00~0.20	6.6±0.2	6.6±0.2	7.3±0.2	0.5~0.8	2.1±0.3
AVEA0610	6.3±0.5	9.7	±0.3	0.00~0.20	6.6±0.2	6.6±0.2	7.3±0.2	0.6~0.9	2.1±0.3
AVEA0807	8.0±0.5	6.8	±0.2	0.00~0.20	8.3±0.2	8.3±0.2	9.0±0.2	0.8~1.1	2.9±0.3
AVEA0810	8.0±0.5	9.7	±0.3	0.00~0.20	8.3±0.2	8.3±0.2	9.0±0.2	0.8~1.1	2.9±0.3
AVEA0812	8.0±0.5	12.0	±0.5	0.00~0.20	8.3±0.2	8.3±0.2	9.0±0.2	0.8~1.1	3.2±0.3
AVEA1012	10.0±0.5	12.3	±0.2	0.00~0.20	10.3±0.2	10.3±0.2	11.0±0.2	0.8~1.1	4.6±0.3

Product Identification

AVEA	0506	M	T	2V5	391
Product Type	Dimensions (DxL)	Capacitance Tolerance	Packaging Code	Rated Voltage	Capacitance
	0506: 5.0x5.8 0645: 6.3x4.5 0606: 6.3x5.8 0610: 6.3x9.7 0807: 8.0x6.8 0810: 8.0x9.7 0812: 8.0x12.0 1012: 10.0x12.3	M: ±20%	T: Taping Reel	2V5: 2.5V 6V3: 6.3V 160: 16V 250: 25V	470: 47uF 101: 100uF

Standard Ratings

Part No.	WV/Vdc (SV)	Capacitance (uF)	Leakage Current (uA)	tan δ	ESR (mΩmax/20°C, 100K to 300KHz)	Rated Ripple Current (mArms/105°C/100KHz)	Sizs Code
AVEA0645MT2V5331	2.5 (2.9)	330	700	0.12	17	2300	0645
AVEA0506MT2V5391	2.5 (2.9)	390	700	0.12	10	3900	0506
AVEA0606MT2V5391	2.5 (2.9)	390	292	0.12	10	3900	0606
AVEA0606MT2V5561	2.5 (2.9)	560	700	0.12	10	3900	0606
AVEA0610MT2V5821	2.5 (2.9)	820	700	0.12	10	4300	0610
AVEA0645MT6V3101	6.3 (7.2)	100	315	0.12	19	2300	0645
AVEA0645MT6V3221	6.3 (7.2)	220	700	0.12	17	2300	0645
AVEA0606MT6V3221	6.3 (7.2)	220	277	0.12	15	3160	0606
AVEA0606MT6V3331	6.3 (7.2)	330	416	0.12	17	3390	0606
AVEA0610MT6V3561	6.3 (7.2)	560	705	0.12	10	4300	0610
AVEA0810MT6V3821	6.3 (7.2)	820	1033	0.12	12	4700	0810
AVEA0810MT6V3102	6.3 (7.2)	1000	1260	0.12	10	5440	0810
AVEA0606MT160470	16 (18.4)	47	376	0.12	25	2500	0606
AVEA0506MT160101	16 (18.4)	100	320	0.12	27	3000	0506
AVEA0606MT160101	16 (18.4)	100	320	0.12	24	2490	0606
AVEA0606MT160181	16 (18.4)	180	576	0.12	22	3300	0606
AVEA0807MT160271	16 (18.4)	270	864	0.12	22	3300	0807
AVEA0810MT160271	16 (18.4)	270	864	0.12	16	4400	0810
AVEA0812MT160561	16 (18.4)	560	1792	0.12	14	4950	0812
AVEA1012MT160102	16 (18.4)	1000	3200	0.12	12	5400	1012
AVEA0645MT250220	25 (28.8)	22	275	0.12	45	2350	0645
AVEA0606MT250470	25 (28.8)	47	338	0.12	40	2100	0606

■ Category temperature range: -55~+105°C

■ Surge voltage: rated voltage*1.15

■ Rated ripple current: Rated ripple current shall be in accordance with standard ratings list.

These current are rms values of sine wave of 100KHz at 105°C

■ Environmental Characteristics

General

Item	Specifications
Measurement condition	Each measurement shall be conducted at a temperature of 15 to 35 °C, and relative humidity of 45 to 85%. Furthermore, these measurements shall be preferably conducted at a temperature of 20±2 °C, and relative humidity of 60 to 70%, while the capacitors shall be kept enough time in the measuring temperature.
Voltage treatment	If leakage current is doubtful, measure it after performing voltage treatment, which shall contain the following steps: (1) Applied DC rated voltage to the capacitors for 60 minutes at 105±2 °C. (2) Cooled down to room temperature with applying voltage. (3) Discharged through a resistor of approximately 1Ω/V.

Electrical Performance Test

Item	Requirement	Test Condition	
Tolerance on Rated Capacitance	In Within standard ratings	Rated capacitance shall meet within ±20% tolerance against the rated capacitance measured at 120Hz±10% at 20±2°C.	
Leakage current	In accordance within standard ratings	DC rated voltage shall be applied between anode and cathode lead wire terminations of a capacitor through 1KΩ protective resistance, and the leakage current shall be less than or equal to the value listed in accordance with electrical specification after 2 minutes with the voltage reaching the rated value at 20±2°C. If the value is doubtful, measure the leakage current after performing voltage treatment as follows Voltage treatment	
Tangent of loss angle (tan δ)	tan δ values shall be less than or equal to 0.12	At 120Hz±10% at 20±2°C.	
Equivalent Series Resistance (ESR)	shall be less than or equal to the value in standard ratings	Equipment: Agilent technology 4263B or equivalent Test fixture: Agilent technology 16047E or equivalent Compensation: Short and open compensation would be required, Short correction is performed using the shorting plate made of 0.5 thickness copper plate with gold coating Signal level: 500mV Frequency: 100KHz Measurement point: Point of lead wire within 1mm form the body	
Impedance at high and low temperature	Impedance ratio	at -55±3°C or 105±2°C, 100kHz	
	Z(-55°C)/Z(+20°C)		≤ 1.25
	Z(-105°C)/Z(+20°C)		≤ 1.25

Mechanical Characteristics Test

Item	Requirement	Test Condition
Adhesion by Soldering	the soldered terminals shall not be damaged	A force of 5N shall be applied for 10 seconds to the capacitor, which was mounted on a print circuit board, in the perpendicular direction to the seal side of the capacitor
Vibration	During this test, measured electrical value shall be stabilized when that capacitor is measured 5 times within 30 minutes before completion of test, and the appearance shall not appear any remarkable abnormality. Capacitance change shall be within ±10% of the initial measured value	Vibration cycle should vary from 10 to 55Hz with total amplitude of 1.5mm and return to 10Hz in about 1 minute. Vibration applied to a capacitor should be three directions, which each perpendicular to the other two as longitudinal axis of capacitor set as z axis, and last for 2 hours in each direction.
Solderability	Solder shall cover at least 3/4 of the lead surface immersed	The lead surface shall be immersed for 2 0.5 seconds in the flux of ethanol or isopropyl alcohol solution (25 2%) of colophonium. Then that lead surface shall be immersed to a solder (H60A, H60S or H63A) of 235 5°C and up to the point 1.5 to 2.0mm from the body and kept for 2 0.5 seconds, and pulling it out
Soldering Heat	the capacitors shall satisfy their test criteria	After the capacitors are soldered by the recommended soldering conditions below, the tests of the item Humidity resistance and Load life shall be conducted

Environmental Performance Test

Item	Requirements	Test Condition
Damp Heat, Steady State		A capacitor shall be subjected to a temperature of $60\pm 2^{\circ}\text{C}$ and relative humidity of 90 to 95% without voltage applied for a period of $1000+48/-0$ hours. Then that capacitor shall be taken out from the above condition to a temperature of 20°C
Endurance	Appearance: No significant damage Capacitance change: $\leq \pm 20\%$ of the initial value $\tan \delta$ & ESR: $\leq 150\%$ of the initial specified value Leakage current: \leq the initial specified value	A capacitor shall be subjected to a temperature of $105\pm 2^{\circ}\text{C}$ with test voltage applied for a period of $2,000+72/-0$ hours and take out from the above condition to a temperature of 20°C . Besides, the applied voltage shall increase up from 0V to test voltage step by step (maximum 5 minutes), and the impedance of the source shall be equal to about $3\Omega/V$.
Surge Voltage		when the capacitors are restored to $+20^{\circ}\text{C}$ after the surge voltage is applied at a cycle of 360 seconds which consists charge for 30 ± 5 seconds through a protective resistor of $1\text{K}\Omega$ and discharge for 330 seconds, for 1000 cycles at $105\pm 2^{\circ}\text{C}$

\odot :DC voltmeter
 R1 :Protective resistor $1\text{k}\Omega$
 R2 :Discharging resistor $1\text{k}\Omega$
 Cx :Capacitor under test

Surge voltage circuit

Reflow soldering

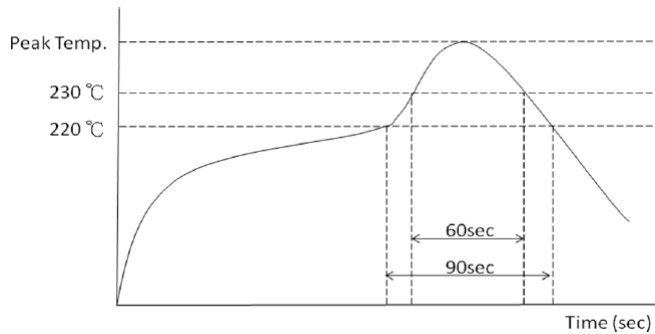

Recommended condition:

Peak temperature(max)	260°C
220°C over time(max)	90sec
230°C over time(max)	60sec
Reflow number	Only 2 time

Soldering Pad Dimensions

Unit: mm

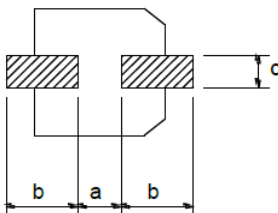

Type	a	b	c
AVEA0506	1.4	3.0	1.6
AVEA0645	2.1	3.5	1.6
AVEA0606	2.1	3.5	1.6
AVEA0610	2.1	3.5	1.6
AVEA0807	2.8	4.2	1.9
AVEA0810	2.8	4.2	1.9
AVEA0812	2.8	4.2	1.9
AVEA1012	4.3	4.4	1.9

■Packaging

Packaging Quantity & Reel Specifications

Unit: mm

Type	A	B	C	W	T	Emboss Plastic Tape (EA)
AVEA0506	381±2	100±0.5	13±0.5	13.5±0.8	2.5±0.3	1,200
AVEA0645	381±2	100±0.5	13±0.5	16.5±0.8	2.5±0.3	1,500
AVEA0606	381±2	100±0.5	13±0.5	16.5±0.8	2.5±0.3	1,200
AVEA0610	381±2	100±0.5	13±0.5	16.5±0.8	2.5±0.3	750
AVEA0807	381±2	100±0.5	13±0.5	25.9±0.8	2.5±0.3	1,000
AVEA0810	381±2	100±0.5	13±0.5	25.9±0.8	2.5±0.3	500
AVEA0812	381±2	100±0.5	13±0.5	25.9±0.8	2.5±0.3	400
AVEA1012	381±2	100±0.5	13±0.5	25.9±0.8	2.5±0.3	450

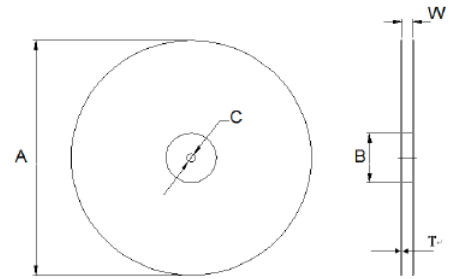

Emboss Plastic Tape Specifications

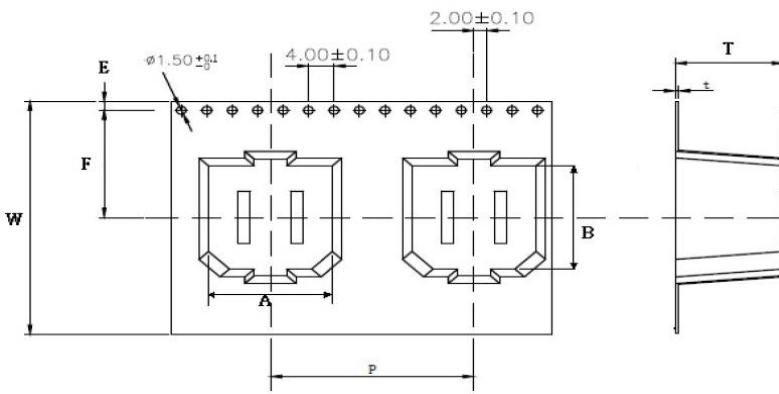

Unit: mm

Type	A	B	W	E	F	P	T	t
AVEA0645	5.7±0.2	5.7±0.2	16.0±0.3	1.75±0.10	5.50±0.1	12.00±0.10	4.8±0.2	0.4±0.05
AVEA0606	6.8±0.2	6.8±0.2	16.0±0.3	1.75±0.10	7.50±0.1	12.00±0.10	6.3±0.2	0.4±0.05

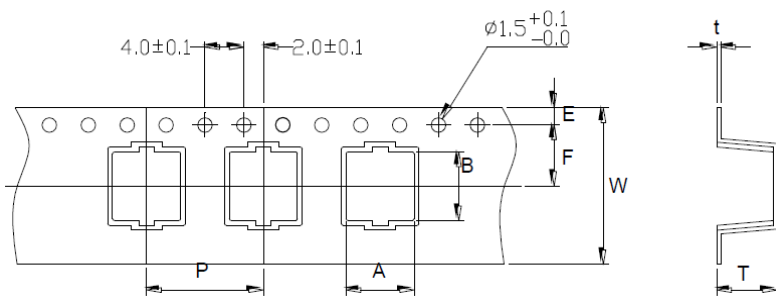

Unit: mm

Type	A	B	W	E	F	P	T	t
AVEA0506	5.7±0.2	5.7±0.2	12.0±0.3	1.75±0.10	5.50±0.1	12.00±0.10	6.2±0.2	0.4±0.05
AVEA0610	7.0±0.2	7.0±0.2	16.0±0.3	1.75±0.10	7.50±0.1	12.00±0.10	10.0±0.2	0.5±0.05
AVEA0807	8.7±0.2	8.7±0.2	24.0±0.3	1.75±0.10	11.50±0.1	12.00±0.10	7.2±0.2	0.5±0.05
AVEA0810	8.7±0.2	8.7±0.2	24.0±0.3	1.75±0.10	11.50±0.1	16.00±0.10	10.0±0.2	0.5±0.05
AVEA0812	8.7±0.2	8.7±0.2	24.0±0.3	1.75±0.10	11.50±0.1	16.00±0.10	12.0±0.2	0.5±0.05
AVEA1012	10.7±0.2	10.7±0.2	24.0±0.3	1.75±0.10	11.50±0.1	16.00±0.10	13.0±0.2	0.5±0.05

■ Instructions of Capacitors

1. Cautions on use of Capacitor

■ Polarity

Solid electrolytic capacitors are polarized capacitors. Use capacitors after verifying their positive and negative polarities. If these capacitors are installed in the reverse polarity, its life may shorten because of increasing leakage current or short circuit.

■ Types of circuits in which capacitors are prohibited from being used AVEA series may be heated by soldering to increase in its leakage current slightly. This may have some influence on the characteristics capacitors in the following circuits.

- (1) Time constant circuit
- (2) Coupling circuit
- (3) High impedance voltage holding circuit
- (4) Connection of two or more capacitors in series for higher withstand voltage.

■ Over voltage

If AVEA series is applied a voltage higher than the rated voltage for an instantaneous period, it may be defected due to short circuit. Note that the voltage over the rated voltage must not be applied to capacitors

■ Repeat of rapid charging and discharging

If AVEA series is used in a rapid charging and discharging circuit or receive the flow of excess rush current, its life may shorten by large leakage current or short circuit. The charging and discharging current through AVEA series should be less than 10A.

■ Reflow Soldering

High soldering temperature and long soldering time will affect the characteristics of the capacitors. Use reflow soldering condition within the recommended range. Also, the temperature varies with the location and population of the components, the material and the thickness of printed circuit board. Verify temperature profiles prior to actual production run.

■ Use of capacitors for industrial equipment

When capacitors are used for industrial equipment, the circuits should be designed to have sufficient margins in the ratings of capacitors including capacitance and impedance. Without sufficient margins in the characteristics, the reliability of the capacitors may be reduced by their shorter life. Always contact us if you want to use capacitors for equipment affecting human lives such as space, aviation, atomic power, and medical devices. Never use capacitors for the used without our prior approval.

2. Notes on circuit designs for capacitors

■ Rating and performance

Use capacitors within the rating and performance ranges defined in the brochures and delivery specification of capacitors after checking the operating and installation environments.

■ Operating temperature

If AVEA series is used at a temperature higher than the upper specified temperature (105°C), its life may be remarkably shortened or the leakage current may increase to cause defective.

■ Ripple current

Never make current larger than the rated ripple current through AVEA series. If excess ripple current flows through AVEA series, internal heat may be generated largely to make its life shortened or cause it to be defected due to short circuit.

■ Leakage current

Depending on the soldering conditions, the leakage current of AVEA series may increase slightly. The application of DC voltage enables the capacitors to be repaired by itself. This leads the leakage current to be smaller gradually. The leakage current can be reduced fast if the DC voltage, which is less than the rating voltage, is applied at the temperature close to the upper specified temperature.

■ Applied voltage

Do not apply voltages exceeding the full rated voltage. If such voltage is applied, it may cause short circuit even though it is just a moment.

- (1) Sum of DC voltage and the peak of ripple voltage AC voltage shall not exceed the rated voltage or category voltage.
- (2) The sum of the DC voltage plus the negative peak AC voltage shall not allow reverse voltage.
- (3) Do not apply reverse voltage.
- (4) For 25V products, the applied voltage shall follow the following figure as the temperature is higher than 85°C ◦

■ Failure mode

AVEA series contains a conductive polymer as material of cathode electrode. Therefore, like other solid electrolyte capacitors, the life ends mostly due to random failure mode, mainly short circuit. If a current continuously flow through the capacitor due to short circuit, the capacitor would be overheated higher than 300°C and then aluminum case of the capacitor would be removed by increasing internal pressure due to the vaporization of materials.

■ Insulation

- (1) Plastic coated case of capacitors is not secured to insulate. Do not use capacitors in areas requiring insulation.
- (2) Isolate the case of AVEA series from the positive and negative terminals and adjacent circuit patterns.

■ Design of printed circuit board

Take note on the subjects when capacitors are installed on printed circuit boards:

- (1) For surface mount capacitors, design the copper pads/lands of a printed circuit board according to the catalog or product specifications.
- (2) Do not place heating components on boards to be close to capacitors or in the backside of them.

■ Parallel connection

If AVEA series is connected with another type of a capacitor in parallel, larger ripple current may flow through one of capacitors. Take the current balance among them into account in circuit designs.

■ Using temperature and frequency

The electric characteristics of capacitors depend on the variations of the ambient temperature and frequency. Check the variations in designing circuits.

3. Notes on installation of capacitors

■ Notes on pre-installation of capacitors

- (1) Do not reuse capacitors installed in a unit with the power supply turned on for another unit. No used capacitors shall be reused excluding those removed to measure their electric characteristics in periodical inspection.
- (2) If AVEA series stored for a long period may often increase in its leakage current, connect a resistor of approximately 1kΩ to the capacitors for voltage treatment.

■Notes at installation of capacitors

- (1) Install capacitors in a unit after confirming that their ratings (rated capacitance and rated voltages) meet the conditions of the unit.
- (2) Install capacitors in the correct polarities.
- (3) Take care not to drop capacitors on floors. Do not use capacitors dropped on floors.
- (4) Do not deform capacitors to install them in units.
- (5) Note capacitors may be damaged by mechanical shocks caused by the vacuum head, component checker or centering operation of an automatic mounting machine.
- (6) Do not dip the body of a capacitor into the solder bath.
- (7) Do not solder capacitors more than once by reflow. Consult us for reflow-soldering them twice over.
- (8) Do not apply mechanical stress to the capacitor after soldering to the printed circuit board.
- (9) Do not use adhesives and coating materials containing halogenated solvents.

■Notes on use of capacitors in unit

- (1) Never make your fingers contact with the capacitor terminals.
- (2) Do not make capacitor terminals to be in contact with each other through a conductor. Do not put conductive liquid such as acid and alkali solutions on capacitors.
- (3) Confirm that the unit including capacitors is placed in proper conditions. Do not place the unit in the following areas:
 - (a) Area in which they are directly exposed to water, brine, or oil or in condensation status.
 - (b) Area filled with poisonous gases including hydrogen sulfide, sulfurous acid, nitrous acid, chlorine and ammonia.
 - (c) Area to which ultraviolet and/or radial rays are radiated
- (4) Provide aging for a unit containing capacitors within the period defined for them.
- (5) It is recommended to use a unit containing capacitors in the normal temperature range of 15°C to 35°C and the normal humidity range of 75% or less.

■Action at emergency

- (1) At the occurrence of short circuit in AVEA series, some heat is generated from it if the short-current rather small. If the short current exceeds the above value, the capacitors are heated excessively. If so, turn off the power of the unit without your face and hands being close to the capacitors.
- (2) If you should expose your eyes to smoke from the capacitor or inhale it, immediately flush the open eyes and gargle with water.

■Storage

- (1) Store capacitors in an area in the temperature range between 15 oC to 35 oC and the relative humidity of 75% or less without direct sunshine. In addition, store them in the package states if possible.
- (2) SMD products are sealed in a special laminated aluminum bag. Use all capacitors once the bag is opened. Return unused capacitors to the bag, and seal it with a zipper. After the bag is opened, please use all capacitors within 6 month.
- (3) Store capacitors in an airtight bag to keep the terminals in good condition.
- (4)Store in a location where the capacitor is not exposed to ozone, ultraviolet radiation, or other radiation.
- (5)Never store capacitors in any area in which they are directly exposed to water, brine, or oil or in condensation status.

■Exhaustion of capacitors

Capacitors are composed of organic compounds, resins and metals. Request an industrial dispose company to dispose of used Capacitors.

4. Export Trade Control Ordinance

Item 41-4 in Section 2 of Appendix Table 1 (Section 49 in Chapter 1 of MITI' s Ordinance) and Item 7 in Section 7 of Appendix Table 1 (Section 6 in Chapter 6 of MITI' s Ordinance) state export regulations on pulse use capacitors (750V of higher) and high voltage use capacitors(5,000V or higher). However, aluminum electrolytic capacitors are less than 750V in their voltage range, so that the regulations do not apply to the aluminum electrolytic capacitors.

■Marking

The color of marking ink is red

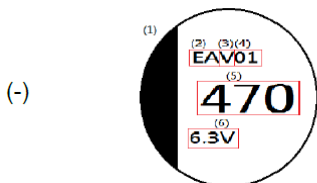

(1)	Polarity	(4)	Production Period Code
(2)	Series	(5)	Rated Capacitance
(3)	Year Code	(6)	Rated Voltage
	EX:Z-2019,A-2020		