

Data Sheet

Customer:	
Product:	Anti-Sulfurated Thick Film Chip Resistor - AS Series (Array)
Size:	0201x2(Flat)/0201x4(Flat)/0402x4/0603x4
Issued Date:	15-Jun-22
Edition:	REV.A5



VIKING TECH CORPORATION
光頡科技股份有限公司
No.70 Guangfu N. Rd., Hukou
Township, Hsinchu County 303,
Taiwan

TEL:886-3-5972931
FAX:886-3-5972935•886-3-5973494
E-mail:sales@viking.com.tw

VIKING TECH CORPORATION KAOHSIUNG BRANCH
光頡科技股份有限公司高雄分公司
No.248-3, Sin-Sheng Rd., Cian-Jhen Dist., Kaohsiung,
806, Taiwan

TEL:886-7-8217999
FAX:886-7-8228229
E-mail:sales@viking.com.tw

VIKING ELECTRONICS (WUXI) CO., LTD.
光頡電子(無錫)有限公司
No.22 Xixia Road, Machinery & Industry Park,
National Hi-Tech Industrial Development Zone
of Wuxi, Wuxi, Jiangsu Province, China
Zip Code:214028
TEL:86-510-85203339
FAX:86-510-85203667•86-510-85203977
E-mail:china@viking.com.tw

Produced by (QC)	Checked (QC)	Approved by (QC)	Prepared by (Sales)	Accepted by (Customer)
15-Jun-22	15-Jun-22	15-Jun-22		
Alice Hsiao	Susan Huang	Susan Huang		

Anti-Sulfurated Thick Film Chip Resistor (Array)

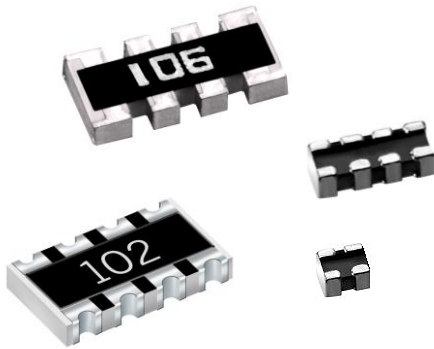

Scope

- This specification applies to all sizes of rectangular-type fixed chip resistors with Ruthenium-base as material.

Features

- Special construction to prevent sulfuration in a sulfur containing environment
- Small size and light weight
- Reduction of assembly costs and matching with placement machines
- Reliability, high quality
- Suitable for IR reflow soldering

Construction

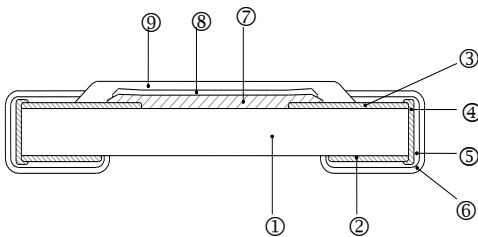

① Alumina Substrate	④ Edge Electrode	⑦ Resistor Layer
② Bottom Electrode	⑤ Barrier Layer	⑧ Primary Overcoat
③ Top Electrode	⑥ External Electrode	⑨ Secondary Overcoat

Applications

- High-end Computer
- Industrial Equipment
- Automatic Equipment Controller
- Medical Equipment
- High-end Multimedia Electronics
- Outdoor Electronic Applications

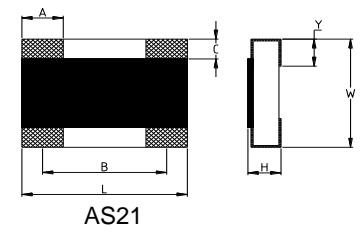
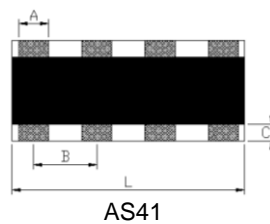
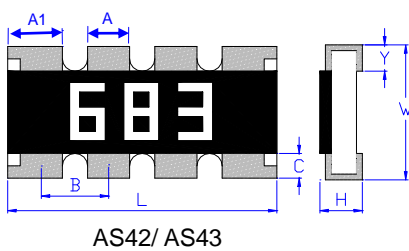

Dimensions

Array:

Type	Number of Resistors	L (mm)	W (mm)	H (mm)	A (mm)	A1 (mm)	B (mm)	C (mm)	Y (mm)	Weight (g) (1000pcs)
AS21	2	0.80±0.10	0.60±0.10	0.35±0.10	0.30±0.10	-	0.50±0.10	0.15±0.10	0.15±0.10	0.500
AS41	4	1.40±0.10	0.60±0.10	0.35±0.10	0.20±0.10	-	0.40±0.10	0.10±0.07	0.15±0.05	0.833
AS42	4	2.00±0.10	1.00±0.10	0.45±0.10	0.30±0.10	0.40±0.10	0.50±0.05	0.22±0.15	0.22±0.15	2.817
AS43	4	3.20±0.15	1.60±0.15	0.55±0.10	0.50±0.15	0.65±0.10	0.80±0.05	0.30±0.15	0.30±0.15	8.288

Part Numbering

AS	42	F	T	F		1002
Product Type	Dimensions	Resistance Tolerance	Packaging Code	TCR (PPM/°C)	Power Rating	Resistance
	21: 0201x2 41: 0201x4 42: 0402x4 43: 0603x4	F: ±1% J: ±5%	T: 7" Taping Reel V: 10" Taping Reel W: 13" Taping Reel	F: ±200 G: ±300	: Standard	0010: 1Ω 1000: 100Ω 1002: 10KΩ 2201: 2.2KΩ 1003: 100KΩ 1004: 1MΩ

Equivalent Circuit Diagram

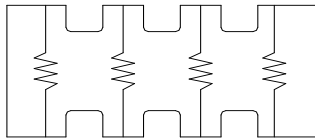

AS42/AS43

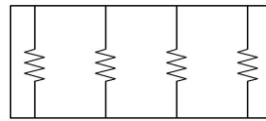

AS41

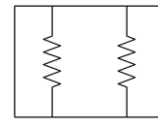

AS21

Recommend Land Pattern

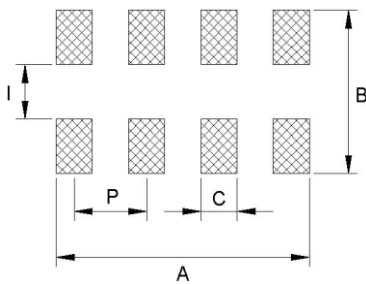

AS41/AS42/AS43

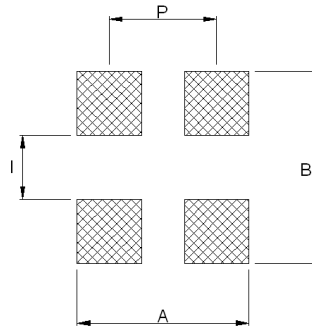

AS21

Type	A (mm)	B (mm)	C (mm)	I (mm)	P (mm)
AS21	0.80	0.90	--	0.30	0.50
AS41	1.40	0.90	0.20	0.30	0.40
AS42	2.10	1.80	0.30	0.50	0.50
AS43	3.10	2.85	0.45	0.80	0.80

Derating Curve

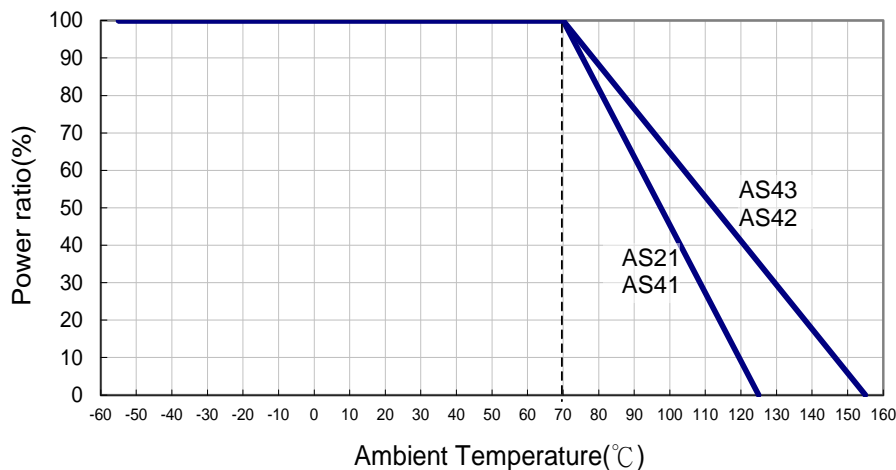

■ Soldering Condition (Ref. IPC/JEDEC J-STD-020 & J-STD-002)

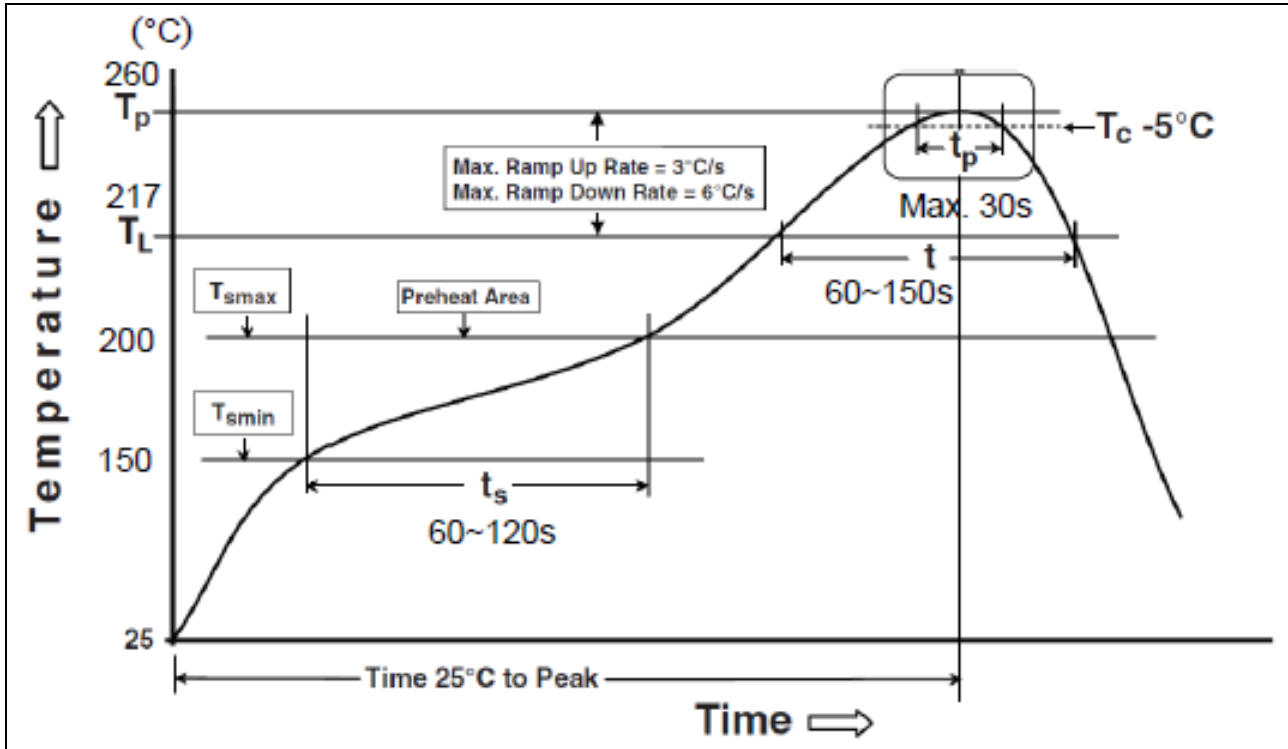

Reflow Profiles	
Profile Feature	Pb-Free Assembly
Preheat Min. Temperature (T _{smin}) Max Temperature (T _{smax}) Preheating time (t _s) from (T _{smin} to T _{smax})	150 °C 200 °C 60-120 seconds
Ramp-up rate (T _L to T _p)	3 °C/second max.
Liquidous temperature (T _L) Time (t _L) maintained above T _L	217 °C 60-150 seconds
Min. Peak temperature (T _p min)	235°C
Max. Peak temperature (T _p max)	260°C
Time (t _p) within 5 °C of the specified classification temperature (T _c)	30 seconds max.
Ramp-down rate (T _p to T _L)	6 °C/second max.
Time 25 °C to peak temperature	8 minutes max.

Standard Electrical Specifications (Array)

Item Type	Power Rating at 70°C	Operating Temp. Range	Max. Operating Voltage	Max. Overload Voltage	Number of Resistors	Resistance Range		TCR (PPM/°C)
						±1%	±5%	
AS21	1/32W	-55 ~ +125°C	12.5V	25V	2	-	3Ω - 9.1Ω	±300
						10Ω - 1MΩ		±200
AS41	1/32W	-55 ~ +125°C	12.5V	25V	4	10Ω - 1MΩ		±200
AS42	1/16W	-55 ~ +155°C	25V	50V	4	10Ω - 1MΩ	1Ω - 1MΩ	±200
AS43	1/10W	-55 ~ +155°C	50V	100V	4	10Ω - 1MΩ	1Ω - 1MΩ	±200

Operating Voltage= $\sqrt{P \cdot R}$ or Max. Operating Voltage listed above, whichever is lower.

Overload Voltage= $2.5 \cdot \sqrt{P \cdot R}$ or Max. Overload Voltage listed above, whichever is lower.

The power rating depends on the maximum temperature of the resistive element. Due to the power dissipation of the resistor, the temperature of the resistive element will rise depending on the condition of heat dissipation from PCB. The maximum power rating in application only applies if the temperature of the resistive element is not exceed 125 °C.

■ Viking is capable of manufacturing the optional spec based on customer's requirement.

Environmental Characteristics

Item	Requirement		Test Method
	±1%	±5%	
Temperature Coefficient of Resistance (T.C.R.)	As Spec.		JIS-C-5201-1 4.8 IEC-60115-1 4.8 At 25°C/-55°C and 25°C/+125°C, 25°C is the reference temperature
Short Time Overload	±(1.0%+0.05Ω)	±(2.0%+0.05Ω)	JIS-C-5201-1 4.13 IEC-60115-1 4.13 RCWV*2.5 or Max. Overload Voltage whichever is lower for 5 seconds.
Insulation Resistance	≥10G		JIS-C-5201-1 4.6 IEC-60115-1 4.6 Max. Overload Voltage for 1 minute
Endurance	±(2.0%+0.10Ω)	±(3.0%+0.10Ω)	JIS-C-5201-1 4.25 IEC-60115-1 4.25.1 70±2°C, RCWV for 1000 hrs with 1.5 hrs "ON" and 0.5 hr "OFF"
Damp Heat with Load	±(2.0%+0.10Ω)	±(3.0%+0.10Ω)	JIS-C-5201-1 4.24 IEC-60115-1 4.24 40±2°C, 90~95% R.H., RCWV for 1000 hrs with 1.5 hrs "ON" and 0.5 hr "OFF"
Dry Heat	±(1.0%+0.05Ω)	±(1.5%+0.10Ω)	JIS-C-5201-1 4.23 IEC-60115-1 4.23.2 at +125/+155°C for 1000 hrs
Bending Strength	±(1.0%+0.05Ω)	±(1.0%+0.05Ω)	JIS-C-5201-1 4.33 IEC-60115-1 4.33 Bending once for 60 seconds, 3mm
Solderability	95% min. coverage		JIS-C-5201-1 4.17 IEC-60115-1 4.17 245±5°C for 3 seconds
Resistance to Soldering Heat	±(0.5%+0.05Ω)	±(1.0%+0.05Ω)	JIS-C-5201-1 4.18 IEC-60115-1 4.18 260±5°C for 10 seconds

Anti-Sulfurated Thick Film Chip Resistor (Array)

Item	Requirement		Test Method
	±1%	±5%	
Voltage Proof	No breakdown or flashover		JIS-C-5201-1 4.7 IEC-60115-1 4.7 1.42 times Max. Operating Voltage for 1 minute
Leaching	Individual leaching area ≤ 5% Total leaching area ≤ 10%		JIS-C-5201-1 4.18 IEC-60068-2-58 8.2.1 260±5°C for 30 seconds
Rapid Change of Temperature	±(0.5%+0.05Ω)	±(1.0%+0.05Ω)	JIS-C-5201-1 4.19 IEC-60115-1 4.19 -55°C to +125/+155°C, 5 cycles
Sulfur Test	±(0.5%+0.05Ω)	±(0.5%+0.05Ω)	ASTM-B-809-95 H ₂ S, 50±2°C, 91~93% R.H., no power rating for 1000 hrs

RCWV(Rated Continuous Working Voltage)= $\sqrt{P \cdot R}$ or Max. Operating Voltage whichever is lower.

■ **Storage Temperature: 15~28°C; Humidity < 80%RH**

■ **Shelf Life: 2 years from production date.**

■ Packaging

Reel Specifications & Packaging Quantity

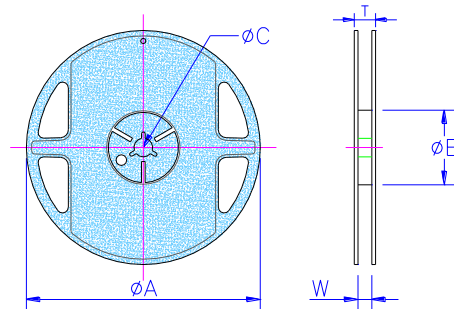

Type	Packaging Quantity		Tape Width	Reel Diameter	ΦA (mm)	ΦB (mm)	ΦC (mm)	W (mm)	T (mm)
AS21 AS41	Paper	10K	8mm	7 inch	178.5±1.5	60 ^{+1/-0}	13.0±0.2	9.0±0.5	12.5±0.5
AS43	Paper	5K	8mm	7 inch	178.5±1.5	60 ^{+1/-0}	13.0±0.2	9.0±0.5	12.5±0.5
		10K	8mm	10 inch	254±1.0	100±0.5	13.0±0.2	9.5±0.5	13.5±0.5
		20K	8mm	13 inch	330±1.0	100±0.5	13.0±0.2	9.5±0.5	13.5±0.5
AS42	Paper	10K	8mm	7 inch	178.5±1.5	60 ^{+1/-0}	13.0±0.2	9.0±0.5	12.5±0.5
		20K	8mm	10 inch	254±1.0	100±0.5	13.0±0.2	9.5±0.5	13.5±0.5
		40K	8mm	13 inch	330±1.0	100±0.5	13.0±0.2	9.5±0.5	13.5±0.5

Paper Tape Specifications

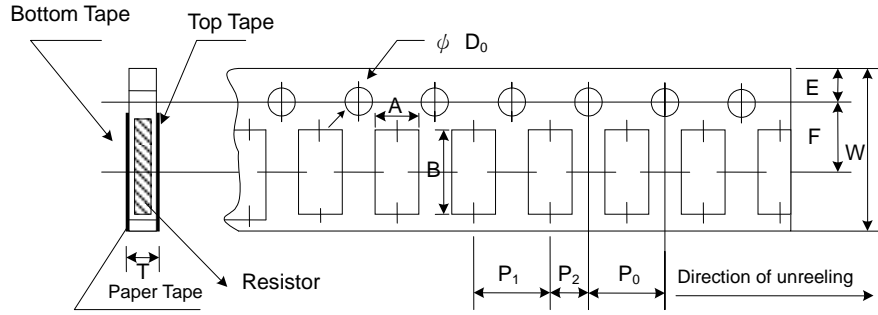

Type	A (mm)	B (mm)	W (mm)	E (mm)	F (mm)	P ₀ (mm)	P ₁ (mm)	P ₂ (mm)	ΦD ₀ (mm)	T (mm)
AS21	0.77±0.05	0.97±0.05	8.0±0.2	1.75±0.1	3.5±0.05	4.0±0.1	2.0±0.05	2.0±0.05	1.50+0.1,-0	0.50±0.1
AS41	0.77±0.05	1.57±0.05	8.0±0.2	1.75±0.1	3.5±0.05	4.0±0.1	2.0±0.05	2.0±0.05	1.50+0.1,-0	0.50±0.1
AS43	1.95±0.1	3.50±0.1	8.0±0.2	1.75±0.1	3.5±0.05	4.0±0.1	4.0±0.05	2.0±0.05	1.50+0.1,-0	0.85±0.1
AS42	1.20±0.1	2.20±0.1	8.0±0.2	1.75±0.1	3.5±0.05	4.0±0.1	2.0±0.05	2.0±0.05	1.50+0.1,-0	0.70±0.1

■ Marking

No Marking for AS21/ AS41

1% for AS43 & AS42: 4 digits marking (non-including E24 series)

Example:

Resistance	102Ω	2.49KΩ	49.9KΩ	121KΩ
marking	1020	2491	4992	1213

1% & 5% for AS43 & AS42: 3 digits marking in E24

Example: 101=100Ω 102=1KΩ (1st and 2nd are E24 code and 3rd code is multiplier)

E24 code	10	11	12	13	15	16	18	20	22	24	27	30	33	36	39	43	47	51	56	62	68	75	82	91

REVISION HISTORY

REVISION	DATE	CHANGE NOTIFICATION	DESCRIPTION
Version A	Sep 4, 2020	-	- Develop a new specification
Version A1	Sep 24, 2020	-	- Add CN-42/CN-43 Dimension A1 - Environmental Characteristics updated
Version A2	Mar 10, 2021	-	- Modify Soldering Condition
Version A3	Nov 15, 2021	-	- Increase the shelf life description
Version A4	Feb 15, 2022	-	- Derating Curve changes the temperature range
Version A5	Jun 15, 2022	-	- Modify Soldering Condition